

FRC CONNECTION INTERFACE CARD

NUMBER OF CHANNELS : 16 PINS
I/P : FRC Male Connector
O/P : Each FRC Connector pin I/P is available on screw fitting terminal connection at O/P.
DIMENSIONS : 70mm x 77mm x 60mm (L X W X H)

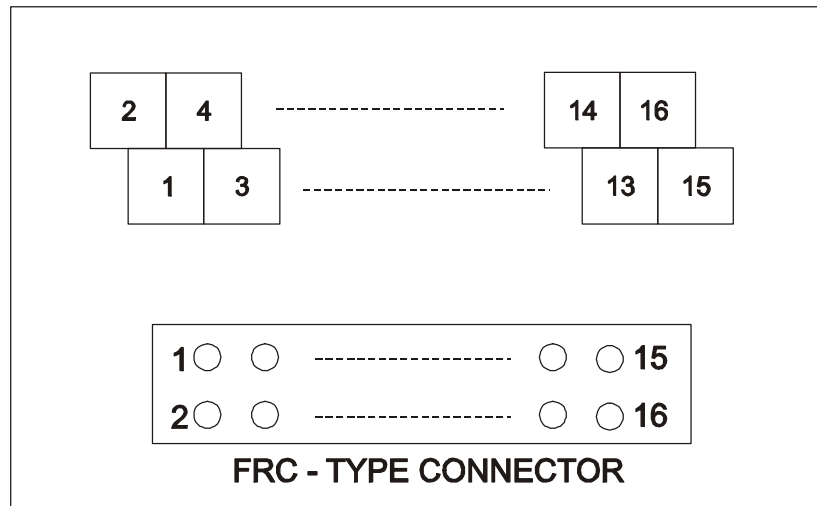
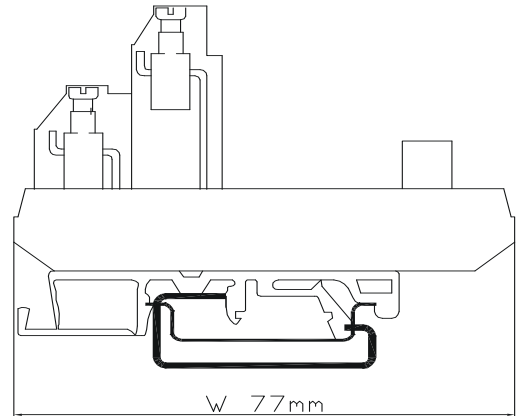
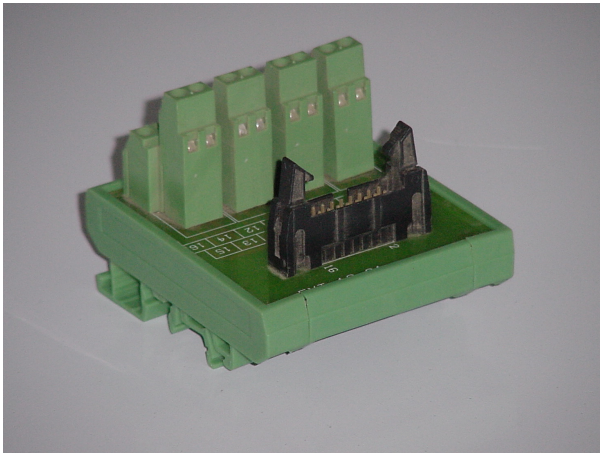

CONNECTORS: PHOENIX MAKE, MKDS, 2.5 sq.mm

ORDER CODE: AI – FRC – 16PIN

Aventek

328, Sonal Link Industrial Estate, Link Road,
Kach Pada, Malad (W), Mumbai – 400 064.
Tel.: 91-22-881 3880 TeleFax:91-22-888 1485
E-mail: aventek@bom3.vsnl.net.in
Web: www.aventekindia.com